



FIMI X8 Tele User Manual

Please read the user manual carefully before using and keep the manual for future reference.

Contents

Services & Support	·1
Package List	·2
Product Instruction	·3
Drone	·6
Safety and Protection	·7
Intelligent flight	·9
Cruise control	·16
ZOOM	·18
Assembly and Disassembly	·19
Intelligent battery	·21
Dual main gimbal Camera	·24
Remote controller	·27
APP	·32
Fly	·35
Maintenance and Calibration	·38
FIMI Enhanced Video Transmission Module	·40
Basic Specification	·44

Services & Support

FIMI provides X8 Tele users with tutorial videos and the following information:

1. FIMI X8 Tele User Manual
2. FIMI X8 Tele Quick Start Manual
3. FIMI X8 Tele Disclaimer and Safety Operation Instructions

Users are advised to watch tutorial videos before using the product and read FIMI X8 Tele Disclaimer and Safety Operation Instructions carefully and get to know the process of using by going through FIMI X8 Tele Quick Start Manual.

For more detailed product information, please refer to FIMI X8 Tele User Manual.

Please download the firmware and watch the tutorial videos on the link

<https://www.fimi.com/download-fimi-x8-Tele.html>

4. Please scan the QR code below to download the APP



Product Instruction

FIMI X8 Tele is a foldable and portable quadcopter that integrates advanced technologies such as aerodynamics, 30X hybrid zoom, 4K 60fps video recording, dual-band transmission, smart control, expansion interfaces, wireless communication, and an infrared sensing system.

It features long-range remote control, real-time image transmission, intelligent flight modes, precise landing, and obstacle sensing. The drone is equipped with a miniaturized 3-axis mechanical gimbal camera, ensuring stable 4K 60fps video recording with a professional ISP processor and high-definition real-time transmission.

The FIMI Navi 3.0 App adopts a minimalist UI design, offering a larger image display, rich features, and fast connectivity. The remote controller features an integrated retractable device holder, supporting up to an iPad Mini, with detachable, storable control sticks.

Reading tips (Symbol description)



Operation prohibited



Important notes



Operation, Usage tips



Glossary, Reference Information

Package List

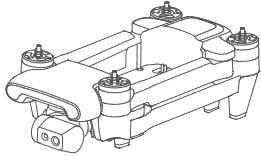

Drone x 1

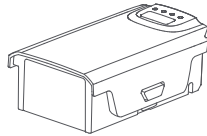

Battery x 1

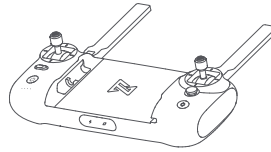

Remote controller x 1



Smart Charging Case x 1

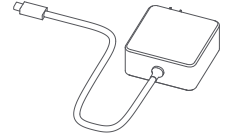

Charger x 1

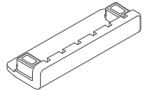

Dustproof plug x 1

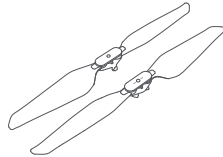

Positive propeller x 3
Reverse propeller x 3



Gimbal protector x 1

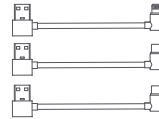

USB cable x 3



Instruction x 2



· This is the standard version display. Please refer to the actual purchased package for details.

Product Introduction

1 Drone

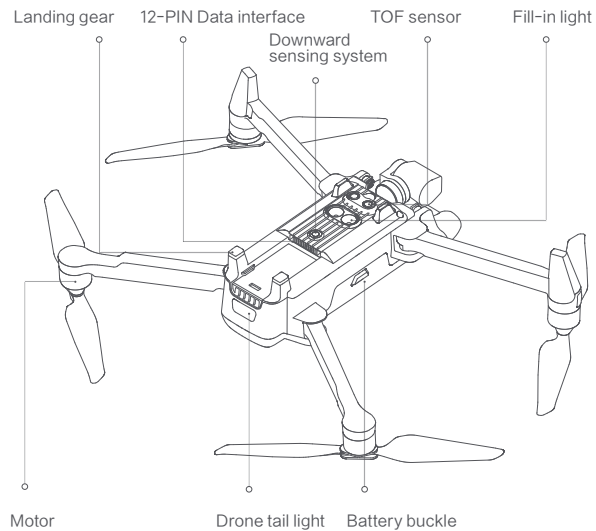
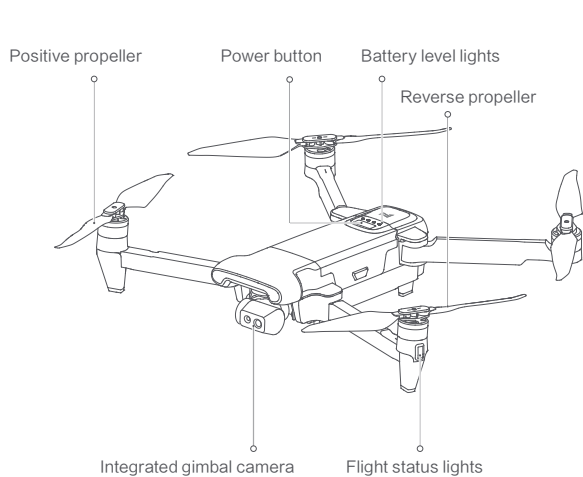

2 Remote controller

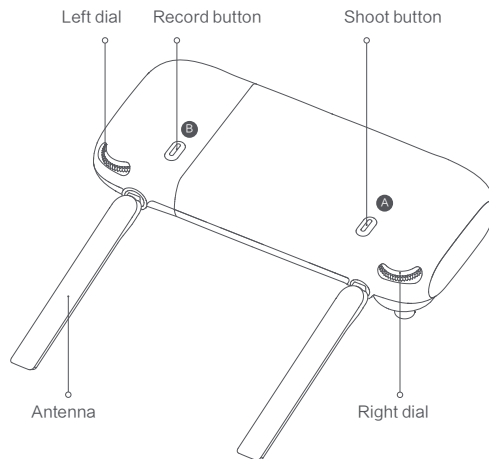
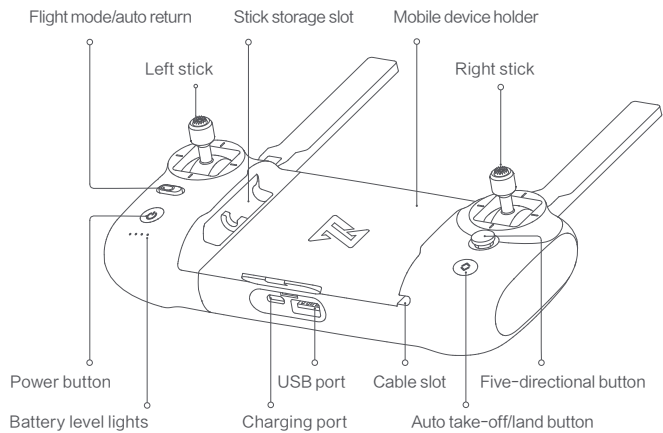

Function Introduction of RC

	Buttons	Function description	
1	Left stick	Push stick upward, the drone goes up; pull stick downward, the drone goes down; toggle stick to left, the drone rotates counter-clockwise; toggle stick to right, the drone rotates clockwise	
2	Right stick	Push stick upward, the drone flies forward; pull stick downward, the drone flies backward; toggle stick to left, the drone flies to left; toggle stick to right, the drone flies to right	
3	Auto return	Toggle the button to the left, switching to normal flight Toggle the button to the right, switching to auto return	
4	Auto take-off/land button	long press 2 seconds to auto take off/landing	
5	Shoot button	short press to start / stop shooting	
6	Record button	Short press to start /stop recording	
7	Five directional button	Up	Default to switch between map / FPV
		Down	Default to switch between gimbal center/down
		Left	Default to turn on / off battery info interface
		Right	Default to turn on / off self-checking interface
		Center	Default to turn on/off media library
8	Left dial	Adjust the pitch angle of gimbal	
9	Right dial	Adjust the value of EV / ISO	
10	Power button	Short press to view the battery level Short press+long press 2 seconds to power on / off	

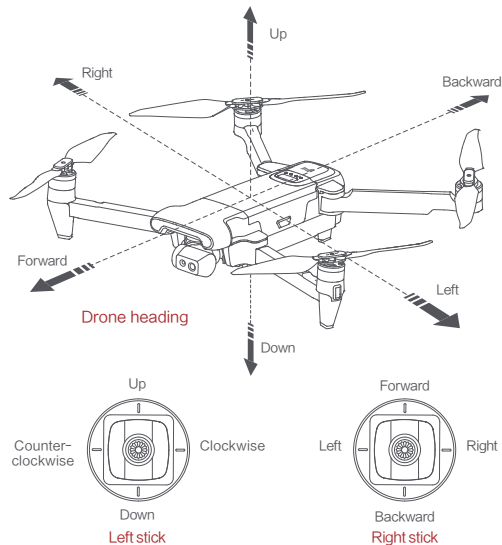

- ⚠ • The other functions of the five-directional button can be set in the FIMI Navi 3.0 App.
- The joystick function is the default mode, which can be set through the FIMI Navi 3.0 App.

- ⚠ • The stick mode can be set in FIMI Navi app (the default is American hand).

Drone

Flight Mode

GPS Mode

To achieve precise hovering, the drone is equipped with a GPS module. The intelligent flight function works in GPS mode. Users can enable Sport Mode or Beginner Mode in the flight settings. When the Beginner Mode is on, the flight speed, flight distance, flight altitude and RTH altitude will be limited. In sport mode, the maximum flight speed is 18m/s(65 km/h), the maximum ascending speed is 5m/s(18 km/h), and the maximum descending speed is 4m/s(14 km/h).

VPU Mode

An Optical Flow module is also built into the drone for precise hovering and landing at the home point. In VPU mode, the Intelligent flight function is not supported. The maximum flight speed is 10m/s(36 km/h), the maximum ascend speed is 3m/s(11 km/h), and the maximum descending speed is 2m/s (7 km/h). When the drone is flying above a well-lit ground with a clear texture and the GPS signal is poor, it will switch automatically to VPU mode.

ATTI Mode

When the GPS signal is poor or the compass has interference, the drone enters in ATTI mode. In this mode, the drone can start drifting horizontally and intelligent flight mode is not supported. Therefore, in case of any accidents, we recommend flying in an open area with good GPS signal reception. Once the drone enters in ATTI mode, please land in a safe place as soon as possible.

- ⚠ At altitudes above 2400 meters, the sport mode will be deactivated.
- When flying in sport mode, the visual system will not function, and the drone will be unable to brake or avoid obstacles actively.
- When flying in sport mode, the drone's speed will be significantly increased compared to normal mode, resulting in a corresponding increase in braking distance.
- When flying in windless environment, users should reserve a minimum braking distance of at least 40 meters to ensure flight safety. During ascent or descent, users should reserve a minimum braking distance of at least 10 meters to ensure flight safety.

Drone Lights

	Drone lights	Drone status
1	All lights are fading in and out	Self-checking
2	All lights are on	Drone on the ground: self-check fails
		Drone is flying: internal error
3	The red/green heading indicator lights flash simultaneously and steadily	Ready to fly / in flight
4	All lights flashing twice	Low battery alerts
5	All lights are flashing quickly	Very low battery alert: land as soon as possible
6	The red and green flashing quickly	The firmware of the drone is updating
7	Fill-in light	Automatically/manually opened

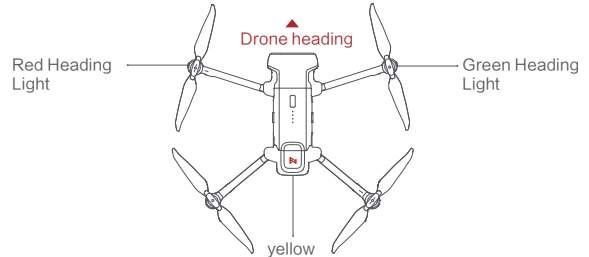

Safety Protection

Failsafe Return

Fimi Navi 3.0 allows setting the behavior of the drone when the remote control signal is interrupted to return, land, or hover. When set to return, if the GNSS signal is strong, the compass is functioning properly, and the return point is successfully recorded, the drone will be deemed disconnected if the signal between the drone and the remote control is interrupted for 2 seconds or more. The drone will then initiate a return flight in the event of disconnection. The flight control system will take over control of the drone and reference the original flight path to plan the return route, guiding the drone back to its takeoff point. If the connection between the drone and the remote control is restored during the return flight, the option to cancel the disconnected return will be available, and control of the drone will be handed back.

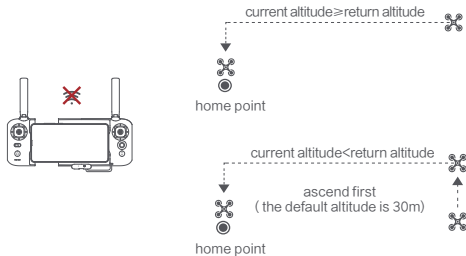

Hovering on the Edge of No-fly-zone

The drone will automatically hover in the restricted flight area designated by the state, such as the edge of airports, and the App will appear corresponding hints. The user can use sticks to fly the drone from the edge of the no-fly-zone, but the drone will not enter the no-fly-zone.



Low-power Protection

In flight, when the battery level is only enough for RTH, App advises users to return, and the drone will return automatically after 10 seconds countdown. When the battery level is only enough for landing, App advises users to land as soon as possible, and the drone will land automatically after 10 seconds countdown. When the battery level is at 15% usage left, the drone will be forced to land.

Intelligent Low Battery Return

When the intelligent flight battery of the drone is critically low and there is not enough power for a return, the user should promptly land the drone. Otherwise, if the battery is completely depleted, the drone will descend rapidly, leading to potential damage or other hazards. To prevent unnecessary risks due to insufficient battery power, the FIMI X8 Pro utilizes information such as flight location, surrounding environment, and real-time wind speed to intelligently determine if the current battery level is sufficient. If the battery level is only enough to complete the return journey, Fimi Navi 3.0 will prompt the user whether to initiate the return process. During the return process, pressing the intelligent return button on the remote control can cancel the return. If the user cancels the low battery return warning and continues flying, it may result in insufficient battery power during the return process, leading to a forced landing and potential loss or crash of the drone.

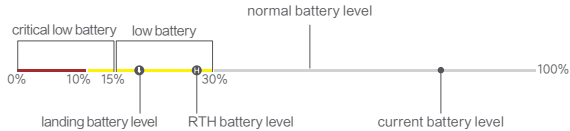

- Inadequate positioning service (such as poor GNSS signal or GNSS failure) may result in the inability to perform a normal return-to-home.
- Before takeoff, it is necessary to enter the safety settings interface of Fimi Navi 3.0 and set an appropriate return-to-home altitude (default is 30m).
- During the return-to-home process, if the environmental conditions, such as low light, do not meet the requirements of the visual system, the drone will be unable to avoid obstacles.
- No-fly zones will affect automatic return-to-home and may result in the inability to complete an automatic return-to-home. Please avoid flying near no-fly zones.
- Strong winds may prevent the drone from successfully returning home. Exercise caution when flying in such conditions.
- Always be aware of small objects (such as tree branches or power lines) or transparent objects (such as glass or water surfaces) along the return-to-home path.
- In case of an emergency, stop the return-to-home process and manually control the drone.

Intelligent Flight

Auto Take-off

When the conditions are right, press Auto Take-off/Landing button for 2 seconds or click the “” button in the FIMI Navi 3.0 app. In GNSS mode, the drone will take off to an altitude of 4 meters and hover for sticks control. In VPU mode, the drone will take off to an altitude of 1.2 meters and hover for sticks control.

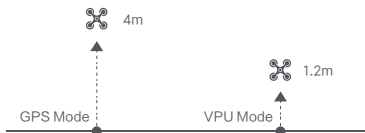

Auto Landing

When the drone meets the conditions for automatic landing, press and hold the automatic takeoff/landing button for 2 seconds or click the “” button in the FIMI Navi 3.0 app. The drone will descend vertically to the ground from its current position. Press the automatic takeoff/landing button briefly or click the “X” button in the FIMI Navi 3.0 app to exit.

Auto Return

When the drone is in flight, the user can toggle the auto return switch to the right to return the drone or click the “” button in the FIMI Navi 3.0 app. When the return distance is less than 10 meters and flight altitude is less than 3 meters, the drone will ascend to 3 meters first and return to the home point; if the flight altitude is greater than or equal to 3 meters, the drone will directly return to the home point. When the return distance of the drone is greater than or equal to 10 meters and the flight altitude is less than 30 meters, the drone will ascend to 30 meters and return to the home point; if the flight altitude is 30 meters or more, the drone will directly return to the home point. The user can toggle the Auto Return Switch or click the “X” button in the FIMI Navi 3.0 app to exit.

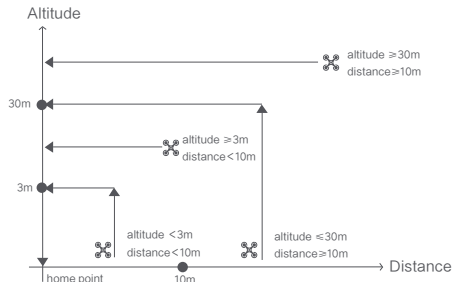

Smart Track

Follow flight is only supported in GNSS mode. Users can enter the Smart tracking menu by clicking on the “” icon in the FIMI Navi 3.0 App. They can then select "Normal Follow," "Parallel Follow," or "Lock Follow." The drone will track the target selected within the app's frame as the tracking target.

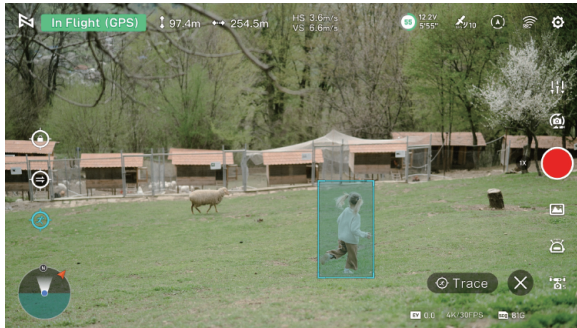

In Trace mode, the heading will always lock at the target and trace it from the back at a distance.



In Profile mode, the heading will always lock at the target and trace it from the side at a distance.

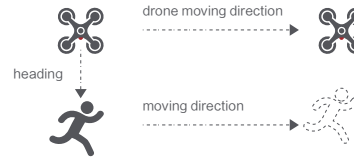

In Lock mode, the drone will hover at a place if flight speed is 0, following the target 360°. The user can also adjust flight speed, and the drone will fly around the target at a certain distance.

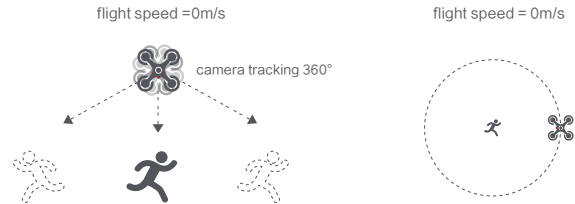

 In Smart Trace, users should always make sure to avoid people, animals and obstacles in the tracking path to ensure the flight safety. Users should comply with local laws and regulations when using the function.

Orbit

The user can select Orbit mode in the App. when a central point and a radius are set, the drone will fly around the central point at a default speed. If a point of interest is set, the camera will be locked at the POI.

- Fly to a central point to set the central point.
- Fly away from the central point to set radius.
- Set flight speed, move direction and heading.
- After setting the parameters, click "GO".

During Orbit mode, you can set the direction and speed of the Orbit flight in the Fimi Navi 3.0 app. Click on the "X" button to exit the Orbit mode.

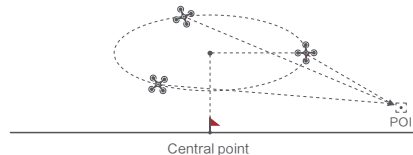
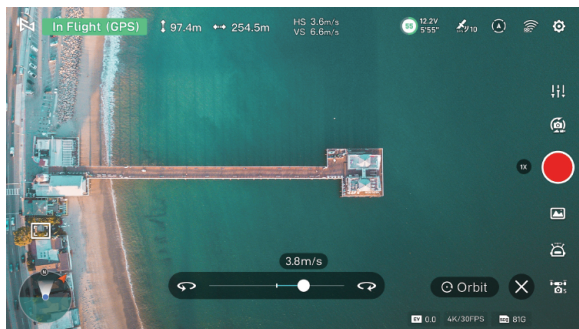

If sticks are moved in flight, the flight altitude or radius will be changed. Taking Mode 2 as example:



Spiral Mode

The user can select Spiral Mode in the App. Set the central point and radius, the drone will spirally fly upward and shoot a video simultaneously, showing a sense of space.

- Fly to a point to set as the central point.
- Fly away the central point to set radius.
- Set spiral direction and flight distance.
- After setting the parameters, click "GO".

During Spiral mode, click on the "X" button to exit Spiral mode.

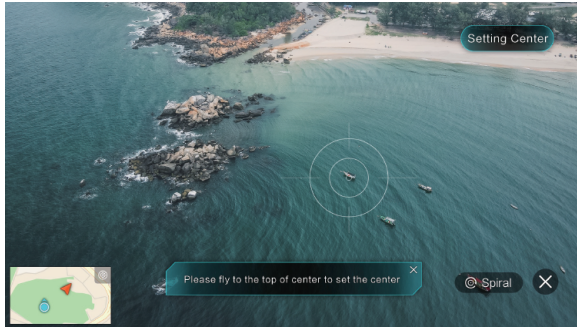
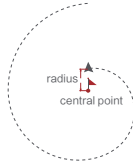

Tap-fly

The user can select Tap-fly in the App. Tap map to choose a destination and set flight speed, the drone will fly over there at a default speed in a straight line. If a point of interest is set, the camera will be locked at the POI

- Tap map to choose a destination
- Switch to image interface to drag a rectangle around the POI
- Set flight altitude and speed

During Tap-fly mode, click on the "X" button to exit Tap-fly mode.

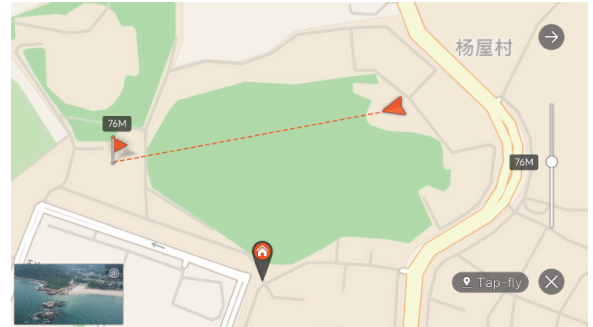

Dronie

The user can select Dronie, including Rocket and Invert, in the App. In Rocket mode, the drone flies upward with the camera pointing downward at the subject to shoot a video. In Invert mode, the drone flies backward and upward with the camera locking at the subject to shoot a video.

- Select the target by framing it.
- Set the flight speed and altitude.
- Click on "GO" to execute. The drone will automatically calculate the flight time and adjust its position. After a 3-second countdown, the drone will start capturing the desired shots.

During selfie flight, click on the "X" button to exit the selfie flight.



Course Lock

Users can select the Course Lock mode in the app. The drone will move forward in the current heading direction and lock the direction. By using the joystick, users can change the heading direction and adjust the shooting angle, while the forward direction remains unchanged. Click on the "X" button to exit the Course Lock mode.

Tripod Mode

Users can select the Tripod mode in the app. The maximum flight speed of the drone is 1m/s, and the maximum rotation speed is 60 degrees/s. In Tripod mode, the sensitivity of the drone is reduced, resulting in a more stable and smooth shooting experience. Click on the "X" button to exit the Tripod mode.

Aerial Mode

Users can select the Aerial mode in the app. In Aerial mode, the braking distance of the drone increases, and the rotation angular velocity is limited, resulting in smoother and more controlled movements. This mode provides a more stable and fluid shooting experience. Click on the "X" button to exit the Aerial mode.

Waypoint

Choosing waypoint and drawing route both are available at map. The drone flies along waypoint route at a default speed. If a point of interest is set, the camera will be locked at the POI. The user can select a way to set waypoints, including choosing points in flight or on the map, historical routes.

Choosing points in flight:

- Control the drone to a point to set as a waypoint
- Using sticks to set flight altitude and heading direction, dials to set gimbal angle, and actions when reaching the waypoint
- When all waypoints ready, please set waypoints routes attribute, including flight speed, heading direction, action at the destination
- POI is enabled when executing waypoints

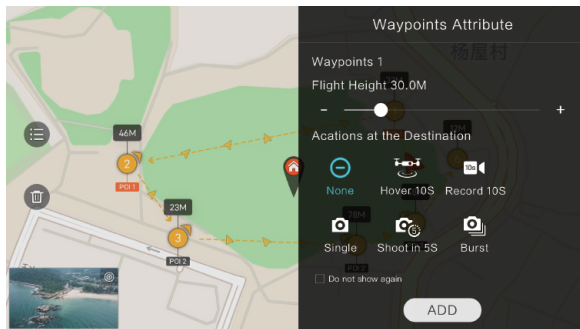

Choosing points on the map

- Tap map to add waypoint
- Set waypoint attribute, including flight altitude, action at the destination, rotate direction
- Drag the POI icon to the map, and set its altitude and relate waypoints
- When all waypoints ready, please set flight speed, failsafe action, and action at the POI is enabled when executing waypoints

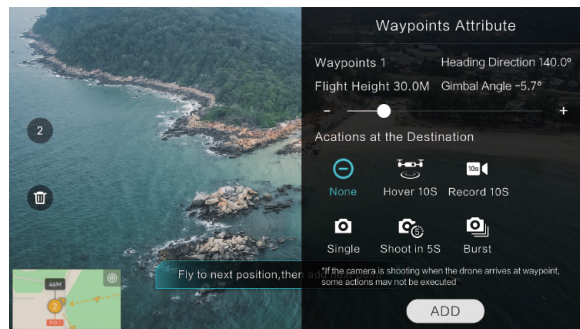

Historical routes

- preview the waypoints and its attribute by entering Favorite list
- tap to start and show the real-time waypoints trace

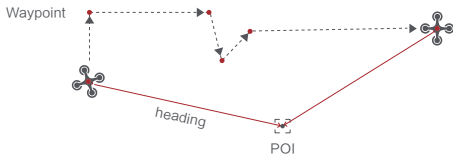

SAR Mode

The user can select SAR Mode in the APP. With real-time GPS coordinates, the drone could help user to search and rescue.

Image interface: show real-time coordinate and time of the drone, support digital zoom, screen shots to share online

Map interface: show real-time coordinate and time of the drone in ordinary map and satellite map, screen shots to share online



Precise Landing

In the process of Return to Home, the optical flow sensor will match landing pad features above the home point. Once matched successfully, the drone will land on the landing pad precisely.

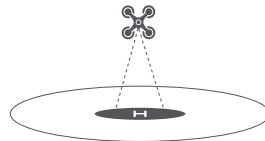

⚠ Please enable precise landing in the app before use it.

Fix-wing Mode

In Fix-wing Mode, the drone can only fly forward, not backward. The user can use sticks to control flight speed and course as showed below (America Mode).

Left stick	push upward	up
	push downward	down
	toggle left	turn left
	toggle right	turn right
Right stick	push upward	accelerate
	push downward	decelerate
	toggle left	turn left
	toggle right	turn right

Cruise Control

The function of cruise control allows the aircraft to lock onto the current horizontal flight speed when conditions permit, enabling it to fly at the corresponding speed without the need for manual control inputs. This helps to avoid the screen shaking that often occurs when manually controlling the aircraft, making the flight more relaxed and enjoyable.

1. Cruise Control Switch

Users can open the cruise control switch in the Fimi Navi 3.0 preview main interface - System Settings - Aircraft - Cruise Control.



2. Enter Cruise Control

Open the cruise control switch, and after the aircraft takes off, long-press the A button on the back of the remote control for 2 seconds to activate cruise control mode.

- When flying forward with the throttle stick engaged, the speed will continue to increase. Upon releasing the throttle stick, the aircraft will maintain its current speed.
- During cruise control, you can adjust the direction by using the yaw and roll sticks. The aircraft will respond to these stick inputs for directional adjustments. Once the sticks are centered, the aircraft will resume cruising at the preset speed.

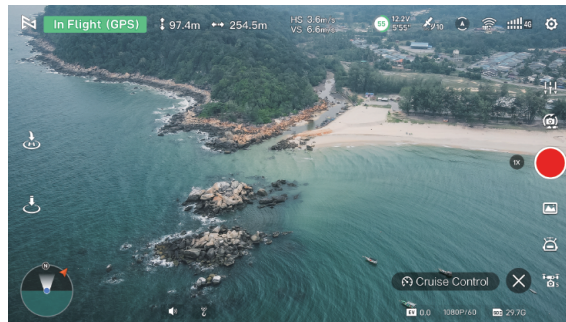

3. Exit Cruise Control

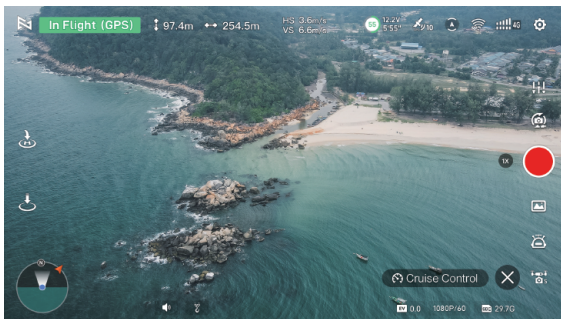

Press the intelligent flight button on the remote control or tap the "X" button on the screen. Alternatively, you can exit cruise control by fully pushing the throttle stick down. After exiting, the aircraft will automatically come to a stop.

- Cruise control can be engaged during Normal, Smooth, and Sport flight modes.
- The aircraft may not enter or will exit cruise control in the following situations:
 - a. When the aircraft approaches altitude or distance limits.
 - b. When there is a disconnection between the remote control or the app.
 - c. When the aircraft encounters an obstacle and stops.
 - d. During automatic return-to-home or automatic landing.
 - e. Switching flight modes will exit cruise control.

- ⚠ • During cruise control, obstacle avoidance status follows the current flight mode's obstacle avoidance settings. Speed will be restricted to the speed set by the obstacle avoidance mode. Please pay attention to flight safety.

zoom

To safely view distant scenes using a telephoto camera, suitable for landscape surveying or pathfinding, click on "5X" to switch to the telephoto camera. Click on "1X" to switch to the wide-angle camera. You can achieve hybrid zoom functionality through the following methods:

- Click the zoom button (e.g., 1x/5x/10x/20x/30x) to perform zoom operations at various magnifications.
- Click the zoom button to expand the zoom bar automatically. Slide the zoom bar to achieve incremental hybrid zoom.
- Long-press the B button on the remote control and scroll the right wheel to control camera zoom (remote control zoom is supported only in 4K/30/25/24, 8M, 12M modes).



- Modes that support 1X to 30X zoom: 4K/30/25/24, 8M, 12M
- Modes that support 1X and 5X zoom: 2.7K/60/50/30/25/24, 1080P/60/50/30/25/24
- Modes that do not support zoom: 4K/60/50, 1080P/120/100, 48M
- During zoom, the yaw stick's corresponding aircraft rotation speed decreases as the zoom factor increases, providing a smoother video capture.

Assembly and Disassembly

Propellers

- Unfold the front and rear arms of the drone.
- Attach the gray marked propellers to the motor mounting base with gray marks on the arms.
- Rotate the propeller to the end of the lock direction until the propeller gets bounced and locked.
- Press the propeller forcefully and rotate the propeller along the unlock direction to remove the propeller.

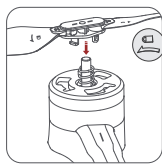
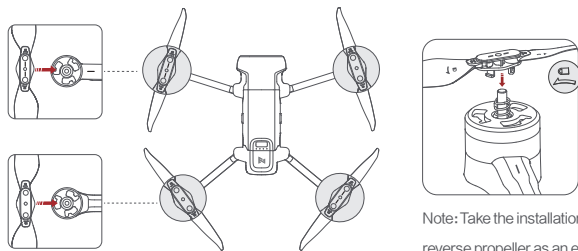

Note: Take the installation of reverse propeller as an example.

- 💡 Please use the FIMI supplied propellers, do not mix different propeller models.
- Please check that the propeller is properly installed and tightened before each flight.
- If the propeller is broken, please replace it with a new one to ensure flight safety and efficiency.
- Do not get near the rotating propeller and electric motor to avoid cuts.

- Before each flight, please make sure the electric motor is firmly installed, without other objects in the electric motor and can rotate freely.
- Do not touch the electric motor directly with your hands immediately after the electric motor stops rotating, as this may cause burns.
- Do not block the electric motor ventilation slot.
- Make sure that the ESC beeps after the power is turned on.

Intelligent Battery

The FIMI X8 Tele intelligent flight battery has a rated voltage of 11.55V. This battery uses high-energy cells and an advanced battery management system with charge and discharge management functions.

- To install the battery, follow the diagram below. You will hear a "click" sound once the battery is in place.
- To remove the battery, press and hold the battery release buttons on both sides of the battery, then pull it out.

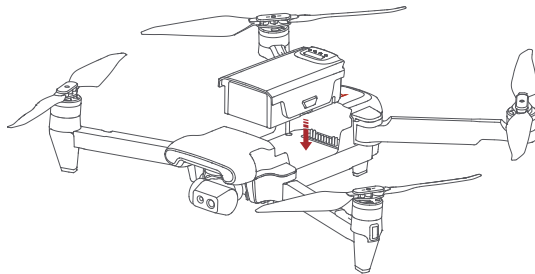

Drone Micro SD card

- When installing SD card to the drone, please unfold the arms of the drone first and open the protection cover
- Insert the SD card with the head side facing upward into the SD card slot
- When removing SD card, press the SD card to pop it out

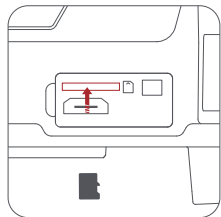

⚠ • Support Micro SD (U3 and above) 8 ~ 256GB.

Intelligent Battery

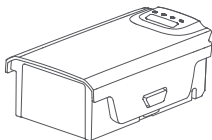

Intelligent flight battery features

1. Power display: the battery comes with a power indicator, which can display the current battery power.
2. Battery storage self-discharge protection: after fully charged and left for 24 hours without any operation, automatic discharge will start, and the battery will be discharged to 65% power to protect the battery.
3. Balance protection: automatically balance the battery internal cell voltage to protect the battery.
4. Over-charging protection: Over-charging will seriously damage the battery and will automatically stop charging when the battery is fully charged.
5. Charging temperature protection: Charging when the battery temperature is below 5°C or above 40°C will damage the battery, and the battery will stop charging when it is outside the temperature range.
6. Charging overcurrent protection: High current charging will seriously damage the battery, and the battery will stop charging when the charging current is detected to be too large.

7. Over-discharge protection: Excessive discharge will damage the battery. When the battery is not used for flight, the battery will be discharged to a certain voltage when Cut off the output. The battery will not enable over-discharge protection during flight.
8. Short circuit protection: The battery will cut off the output to protect the battery if it detects a short circuit.
9. Cell damage detection: If the battery detects cell damage or serious imbalance, the APP will indicate that the battery pressure difference is too large or the cell is damaged.
10. Communication: The drone can get the battery information in real time through the communication interface on the battery, such as voltage, power, current, etc.

Check the power level

Short press the power button to check the current power level.

The power indicator can be used to show the power of the intelligent flight battery during charging and discharging, the indicator is defined as follows.



Indicates that the LED is always on



Indicates that the LED is flashing regularly



Indicates that the LED is of



Indicates that the LED is flashing rapidly

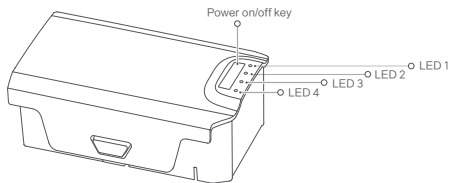

Power level	LED 1	LED 2	LED 3	LED 4
100%	●	●	●	●
75%-99%	●	●	●	●
50%-74%	●	●	●	○
25%-49%	●	●	○	○
0%-24%	●	○	○	○

Power On and Off

To turn on/off the battery, perform a short or long press on the battery button for more than 2 seconds. When the battery is on, the power indicator light will display the current battery level.



Precautions for Low-Temperature Use:

- When using the battery in a low-temperature environment (-5°C to 15°C), ensure that the battery is fully charged. The battery's discharge capability is reduced at low temperatures. Before flying, hover the drone to warm up the battery.
- Flying with the battery in an environment below -5°C is not permitted.
- If the APP indicates a low temperature, immediately return and stop the flight, allowing the battery to warm up or reach full charge.
- It is recommended to preheat the battery to above 10°C or even better, above 20°C, in a low-temperature environment before flight.

Charging

- The power indicator during charging follows the following guidelines:
- Connect the battery, charger, and AC cable as shown in the diagram and turn on the power.
- The battery indicator will flash while charging is in progress.
- When the battery is fully charged, the battery indicator will turn off.
- It takes approximately 2 hours for the smart battery to fully charge.

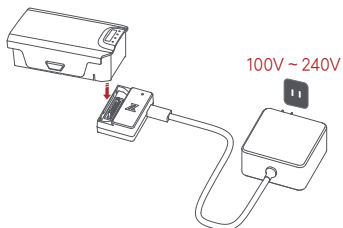

The power indicator during charging is as follows:

Power level	LED 1	LED 2	LED 3	LED 4
0%-24%				
25%-49%				
50%-74%				
75%-99%				
Full				

- ⚠ • After the flight, if the battery temperature is high, it is necessary to wait for the battery to cool down to room temperature or remain idle for 30 minutes before charging
- The recommended charging temperature range for the smart battery is $25 \pm 3^{\circ}\text{C}$, as charging within this range can extend the battery's life.
 - Recharge and discharge the battery every 3 months to maintain battery activity.

- Use the official charger provided by FIMI for charging the smart battery. FIMI will not be held responsible for any consequences resulting from the use of non-FIMI chargers.
- For safety reasons, during long-distance or prolonged transportation, it is advisable to keep the smart battery at a low level, such as below 50%.

- 💡 • For safety reasons, smart batteries need to be kept low (such as below 50%) during long-distance or long-term transportation

Charge and Discharge Protection Indication Messages:

The battery LED provides information regarding battery protection triggered by charging anomalies.

Protection	Display definition	LED 1	LED 2	LED 3	LED 4
Over-discharge protection	LED 1,2 and LED 3,4 Flashing alternately				
Other protections	Fast flashing				

Smart Charging Case Indicator Lights Description:

Indicator Light Patterns	Flashing Description
Always on	The power supply of the charging case is normal
flashing regularly	Charging
Off	Charging complete

Dual main gimbal camera

FIMI X8 Tele gimbal is an integrated gimbal system that utilizes three-axis mechanical stabilization technology, providing a stable shooting platform for the camera. The pitch axis can be controlled to rotate within a range of 10 to -90 degrees. This angle can be adjusted using the left wheel on the remote control or through the FIMI Navi 3.0 app interface. It features the first dual-camera system: a 1/2-inch CMOS wide-angle camera and a 5x telephoto camera. This setup allows seamless switching between different focal lengths to easily handle various shooting scenarios.

Equip and remove the gimbal protector

Equip and remove the gimbal protector as show

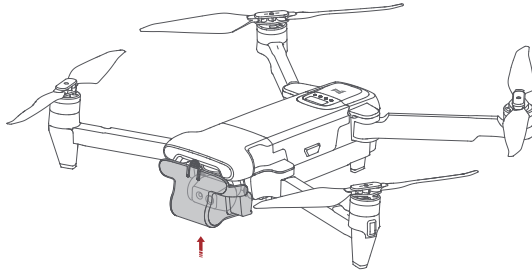

Gimbal

FIMI X8 Tele gimbal is an integrated gimbal system that utilizes three-axis mechanical stabilization technology. It provides a stable shooting platform for the camera, with angular jitter of $\pm 0.005^\circ$. This ensures that the aircraft can capture smooth and stable footage even during high-speed flight.

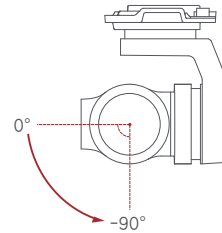

Operating Mode

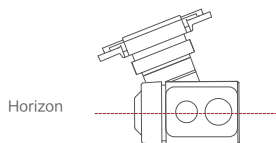

Follow Mode:

The roll axis does not move with the drone and always keep the gimbal horizontally, which suits for shooting stable videos

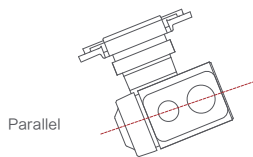

FPV Mode:

The roll axis rotates with the drone to provide a first person view

Camera Overview

The X8 Tele is equipped with the first dual-camera system, featuring a 1/2-inch CMOS wide-angle camera and a 5x telephoto camera. The wide-angle camera has an aperture of $F/1.79$ and an equivalent focal length of 24mm, while the telephoto camera has an aperture of $F/3.0$ and an equivalent focal length of 120mm. The wide-angle camera supports 4K 60fps video recording and captures photos at 48 megapixels. The telephoto camera can record 4K 30fps video with 5x optical zoom and takes photos at 12 megapixels. The hybrid zoom can achieve up to 30x magnification.

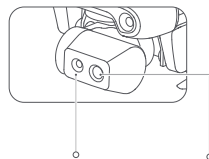

Wide-angle camera Telephoto camera

- ⚠ Before takeoff, please ensure that the drone is placed on a flat and open ground. Avoid colliding with the gimbal after powering on the drone.
- The gimbal contains delicate parts, and any impact or foreign object interference can result in damage and a decrease in gimbal performance or render it unusable. Please handle the camera head with care to avoid physical damage.
- Keep the camera head clean and avoid contact with sand, magnetic materials, or other foreign objects that may block or affect its performance.

- In the case of the camera placed on potholes or grass, or when the gimbal experiences excessive external forces (such as bumps or jams) from ground objects, the gimbal motor may enter a protected state.
 - Do not attach additional objects to the camera head, as this can affect its performance and potentially damage the motor.
 - Before turning on the camera, remove the protective cover. During storage or transportation, use the storage cover to protect the camera head.
 - To clean the lens surface from dirt or dust, it is recommended to use professional lens cleaning tools to avoid damage and maintain image quality.
 - Avoid inserting or removing the SD card while the drone is powered on, as it may damage the card and result in data loss.
 - To ensure camera system stability, limit the duration of a single recording session to 5 minutes or less.
 - Before shooting, double-check the camera's relevant parameter settings to ensure they are correct.
 - When using this device to capture important footage, it is recommended to perform several test shots before the actual recording to ensure that the device is in normal working condition.
 - Properly turn off the smart flight battery to save camera parameters and prevent video damage.
- FIMI is not responsible for any damage caused by unreadable videos or photos.

Image Storage and Export

Storage:

FIMI X8 Tele is equipped with a microSD card slot for expanding storage space. High-quality video and photo shooting require storage devices that support fast write speeds. It is recommended to use microSD cards with SDXC or UHS-I specifications to ensure optimal shooting performance. For detailed information, please refer to the recommended SD card list in the specifications.

Export:

To export image data from the drone to a computer by connecting them or use a card reader.

Remote controller

With ergonomic design, it is easier and more precise to control. There is no complicated operation to connect App, just plug in and it works. The remote controller fully charged can work about 4.5 hours.

Turning on and off

- Short press+long press power button 2 seconds to power on/off
- Short press to check battery level

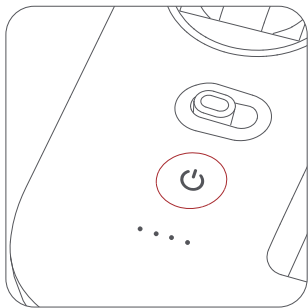

Charge

- Connect the remote controller to a power adapter as show below
- When the RC is in charge, the battery level lights are flashing
- When the RC is fully charged, the battery level lights go out
- It takes about 2.5 hours to fully charge the RC in the powered off condition

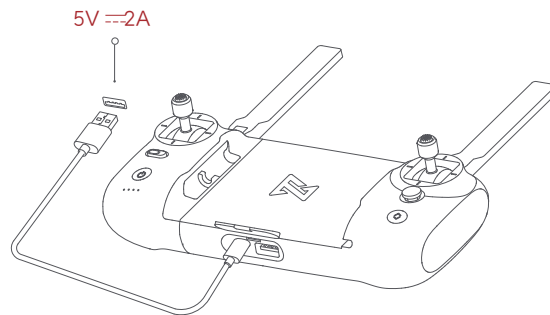

Assemble Device

- Tighten the mobile or pad on mobile device holder by extending the holder to the left.
- Open the interface protection cover on the RC bottom.
- Connect your phone and the RC with a USB cable.
- Connect the drone and update firmware according to instructions in FIMI App.

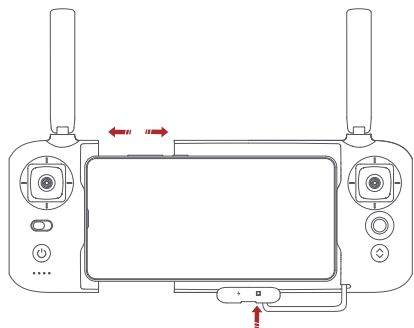

• The cable slot is reserved on the right side of the RC.

Recording and Photo Shooting

- Press the shoot button to take a photo. A photo is taken when you hear 2 short sounds.
- Press the record button to record video. Recording starts when you hear 2 short sounds. Press again to stop recording with 4 short sounds.
- The pitch angle of the gimbal can be controlled by toggling the left dial up and down.
- The right dial can adjust EV/ISO.

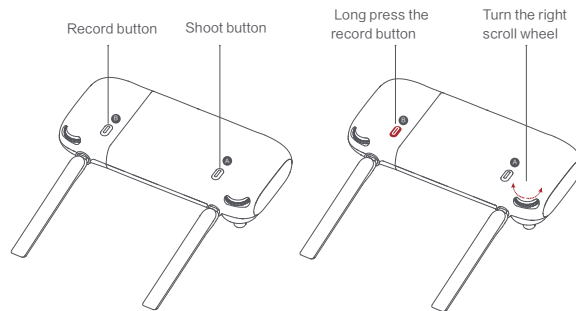

Shortcut Buttons

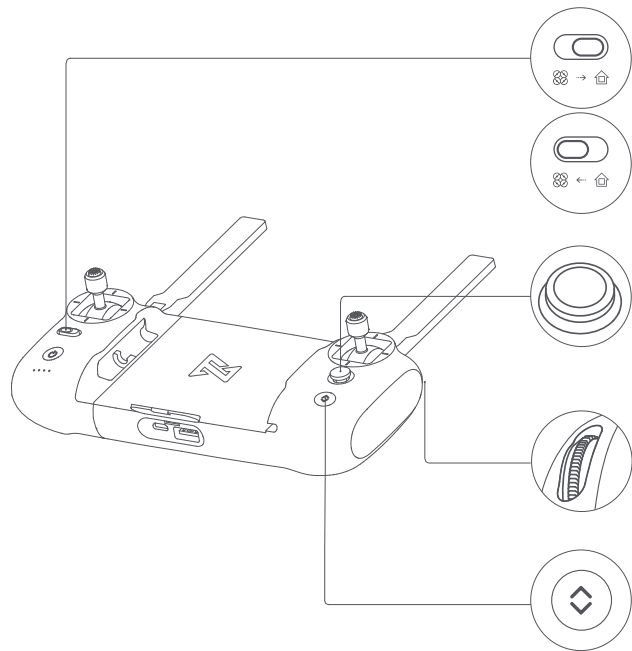

- Toggle the auto return button to the right when the drone is in flight, the drone will return to the home point.

- In the process of auto return, toggle the auto return button to the left, the drone will hover at place and wait for sticks instructions.

- Push the five-directional button up default to access map or FPV

- Push the five-directional button down default to gimbal center or down

- Toggle the five-directional button left default to turn on/off battery info interface

- Toggle the five-directional button right default to turn on/off self-check interface

- Press the five-directional button center default to turn on/off media

- Right dial to adjust EV/ISO value

- Left dial to adjust pitch angle of gimbal

- When auto take-off/land button turns white, it can be pressed to take off or land

- When the drone meets auto take-off conditions, long press 2 seconds to take off

- When the drone meets auto land conditions, long press 2 seconds to land

- When the drone is executing intelligent flight, short press this button to exit

Sticks Control

Mode 1

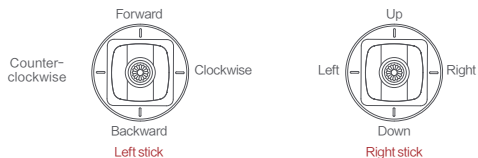

Mode 2

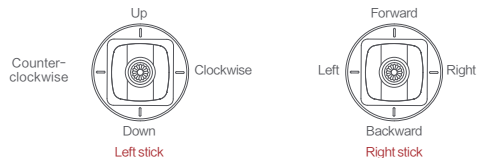

Mode 3

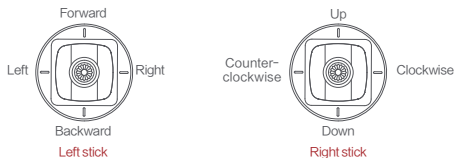

Remote Controller Pairing

When a new remote controller or drone is replaced, please pair the remote controller and the drone again as shown below:

- Turn on the drone
- Turn on the RC, long press the power button 15 seconds until hearing constant beep sound, and the power button red light flashes
- Short press the code pairing button on the drone, the yellow light on the drone goes out
- The code pairing succeeds when the power button on the RC turns white and the yellow light on the drone keeps on

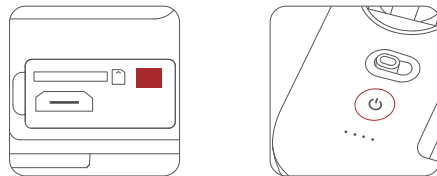

Remote lights

	Remote lights	Remote status
1	Power button's red light are on	Weak signal
2	Power button's red light flashes	Not connected to the drone
3	Power button's red light flashes	RC Pairing or upgrading firmware
4	Power button's white light is on	Normal signal
5	Power button's white light flashes	Recording videos
6	Auto take-off/landing button's red light is on	Auto take-off or landing not enabled
7	Auto take-off/landing button's white light on	Ready for auto take-off

Basic Flight Operations

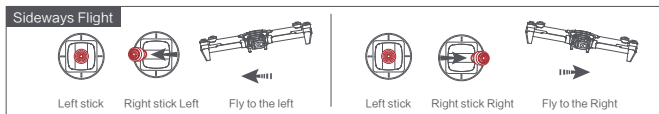
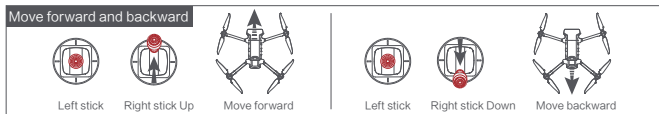
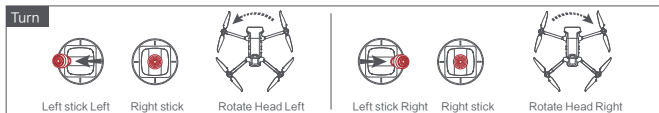
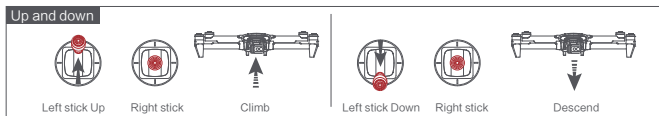

Note: The stick mode can be set in FIMI Navi app (the default is American hand).

Remote controller communication range

- When operating the aircraft, it's important to promptly adjust the orientation and distance between the remote controller and the aircraft, as well as adjust the antenna position to ensure the aircraft remains within optimal communication range.
- When the antenna forms a 180° or 270° angle with the back of the remote controller, it can optimize the signal quality between the remote controller and the aircraft.

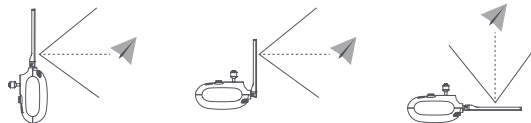

- ⚠ • Please do not use other communication devices operating on the same frequency band simultaneously to avoid interfering with the remote controller signal.

APP

After downloading and installing the APP, register the FIMI user account and log in. Click to enter the flight interface, or you can use it without logging in.

△ · Some features, such as flight logs, will not be available without logging in.

Image Interface

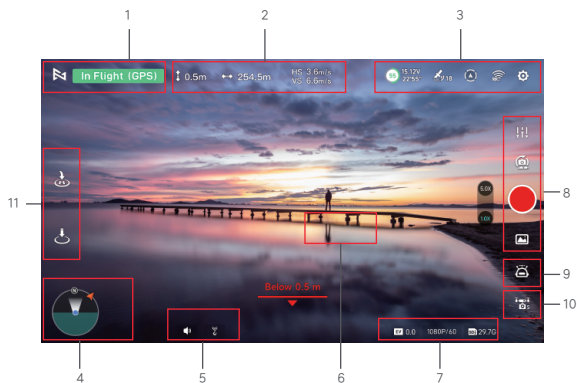

1. Real-time Flight Parameters

🏠 : Tap to return to the home screen.

In flight : Current flight status

GPS : Current flight mode, including GPS, VPU, ATTI

2. Drone Status

↓ **0.5m** : Vertical flight altitude from the home point

↔ **254.5m** : Horizontal distance from the home point

VS 6.6m/s : Vertical speed

HS 3.6m/s : Horizontal speed

3. Signal Status and General Settings

📶 : Show GPS signal status, 0-6 indicates poor with red; 7-12 indicates good with yellow; 13 and above indicate excellent with white.

⚙️ : Tap to enter flight control settings

📶 : Show the RC signal strength, tap to enter RC setting

🔋 : The numerical value inside the circle represents the battery power percentage. The adjacent values indicate the voltage and remaining flight time. Click to access battery settings.

🚫 : Displays the status of the obstacle avoidance function, click to enter the obstacle avoidance settings.

4. Attitude ball

 : Displays the drone head orientation, tilt angle, remote control position and other information. Click to switch the map to display the aircraft in real time Location.

5. Megaphone & Dispenser module

After the Megaphone with release-and-drop module is inserted into the aircraft, it will be displayed after powering on.

 : Megaphone

 : Low altitude distance

6. Metering Mode: Tap any place in the image interface for metering, when appearing exposure lock button, click to lock the value.

7. Gimbal and Image Parameters

 : Show the current EV value.

 : Camera parameter settings, tap to set EV,ISO,shutter,video or photo mode, resolution, video size, white balance, etc.

 : Show the capacity of SD card and its residue.

8. Camera Operation Area

 : Display the current zoom factor, click to enter zoom settings.

 : Camera parameter settings, tap to set EV,ISO,shutter,video or photo mode, resolution, video size, white balance, etc.

 : Tap to switch between photo and video record.

 : Tap to start/stop shooting photos or record videos.

 : Media library, tap to download or preview videos and photos saved in Micro SD card.

9. Intelligent Flight

Enter the intelligent flight page, where you can perform one-click auto takeoff, landing, and return to home. It supports waypoint navigation, orbit mode, waypoint flight, selfie mode, spiral flight, as well as shooting in tripod mode and aerial photography mode.

 : Auto Take-off

 : Auto Landing

 : Auto Return

 : Waypoints

 : Smart Track, including Trace, Profile, Lock

 : Orbit

 : Tap-fly

 : Dronie, including Rocket and Invert

 : Spiral Mode

 : SAR Mode

 : Aerial Mode

 : Tripod Mode



 : Course Lock

 : Fix-wing Mode

10 Drone gear mode







-  : Display the current aircraft gear mode, click to switch between "Sport" "Normal" "Cine" mode
- Sport: Max horizontal speed 18m/s, Max ascent speed 5m/s, Max descent speed 4m/s
 - Normal: Max horizontal speed 10m/s, Max ascent speed 4m/s, Max descent speed 3m/s
 - Cine: Max horizontal speed 6m/s, Max ascent speed 1.5m/s, Max descent speed 1.5m/s

11. Shortcuts

-  : Tap to auto takeoff.
-  : Tap to auto land the drone.
-  : Tap to return the drone.

Map Interface



-  : Tap to center the drone.
-  : Display the location of the drone.
-  : Display the location of the Home.
-  : Display the location of the phone.
-  : Tap to correct the direction.
-  : Switch the map.
-  : Home point.

Fly

Confirm the drone heading

- The direction of integrated gimbal camera is the drone heading.
- Once the drone is turned on, the heading can be told by navigation lights.
- The red light and the green light indicate the heading, and the yellow light is the tail.

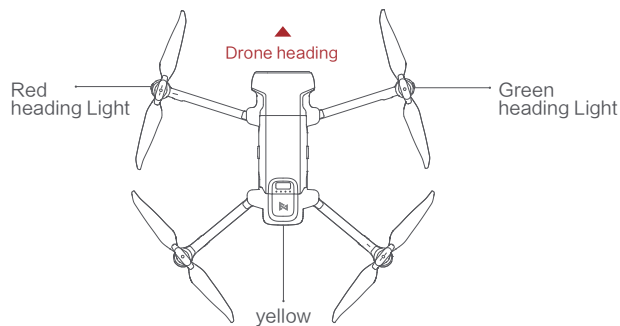

⚠ • Always keep the tail pointed at the user to avoid direction misjudging.

Pre-flight inspection

- Make sure the battery of the aircraft and the remote control are fully charged.
- Make sure that the propeller is installed correctly and that the propeller is not damaged or deteriorated.
- Make sure the camera lens is clean.
- Make sure the SD card is inserted.
- Make sure the front and rear propellers are extended in place
- Whether the camera and gimbal work normally after powering on
- Make sure the FIMI Navi 3.0 is running normally

Automatic take off / landing



Manual take off

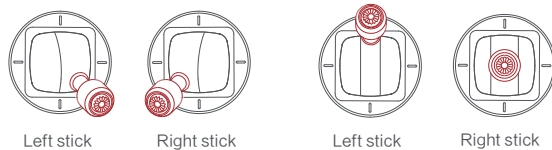

- ⚠ • Keep both sticks to the bottom inner still over 3 seconds, the propellers start spinning.
- Release both sticks once propellers have been spinning, and firmly push the left stick upward to take off the drone.
- During flight, release both sticks to hover
- At any time during controlled flight, release the sticks and the drone will hover automatically.
- 💡 • When pushing the left joystick upward to take off, it is necessary to be decisive. Pushing the left joystick too slowly may cause the aircraft to tilt and flip.

Manual take landing

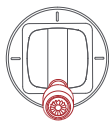

Left stick



Right stick

- Slowly move the left stick downward to land the drone
- Once the drone has landed, push and hold the left stick down over 5 seconds, the motors will stop

Stop propellers in an emergency

When motors can't properly turn off, please toggle the left stick to the bottom inner in maximum range, and press Auto take-off/landing button for 5 seconds simultaneously, the motors will stop.

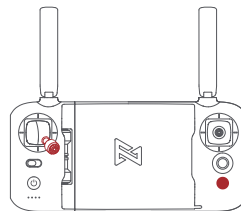

- 💡 • Do not do the above operation during normal flight to avoid motors being stopped in the air.

Flying Condition Requirement

1. The drone is suitable for people above 18 years who have full civil capacity.
2. Make sure to keep some distance from people, animals, trees, vehicles and buildings while using the drone. Please be careful when someone approaches.
3. Keep away from airports, railways, highways, high-rise buildings, utility poles and other dangerous environments when operating the drone.
4. Keep away from the areas with complex electromagnetic signals such as communication base stations and high-power antennas when operating the drone.
5. The flight altitude and distance of the drone corresponding to the take-off point will be limited based on relevant regulations and policies.
6. Do not use this product at the place and time prohibited by regulations and policies.
7. To protect the legitimate rights and interests of users, please follow the product safety instructions when using.
8. Do not operate the drone in bad weather such as strong winds, rain, snow, or fog.
9. Please operate the drone in a broad place with a good GPS signal.
10. It is suggested that user should make the first flight under the guidance of an experienced pro.

Maintenance and Calibration

Remote Controller Calibration

Please try to calibrate the remote controller when you detect inconsistencies between stick control and drone flying.

- Select "RC Calibration" in the remote controller menu.
- Tap "Start" to calibrate the center, do not move sticks .
- Skip to sticks calibration once the center calibration succeed.
- Skip to dial calibration once the sticks calibration succeed.

 • Please turn off the power of the drone before calibrating the remote controller. RC calibration is not available in flight.

Compass Calibration

The compass may need to be recalibrated when there are changes in the magnetic field to ensure proper flight. If the aircraft requires compass calibration, the app will provide corresponding prompts.

- Open the app and access the system settings.
- Scroll down the menu and select "Compass Calibration," then tap to enter calibration mode.
- Follow the on-screen animation prompts and rotate the aircraft accordingly.
- When the screen displays "Calibration Successful," the compass calibration is complete.

 • Please connect the drone before calibration. Compass calibration is not available in flight.

Gimbal Calibration

- Click "gimbal calibration" and enter the calibration page in the gimbal settings menu.
- After the drone is placed smoothly, click to start calibration. Do not move the drone during the calibration process.
- After the calibration is completed, the App interface shows "Calibration succeed".
- If the App interface shows "Calibration failed", please recalibrate.

Flight Data

The FIMI X8 Pro flight control is equipped with a flight logging function, which stores all relevant data after the drone is powered on in the flight control system. The FIMI Navi 3.0 App also has a flight logging function, allowing users to save or delete the related data locally at their discretion.

Propellers Maintenance

Propellers are wearing parts. When they're damaged, replace them in time to ensure flight safety and efficiency.

Battery Maintenance

Do not throw the battery into fire; Do not batter the battery; Lithium battery's capacity reduces significantly in low temperature conditions. Do not use the battery when it is below 5 degrees. Do not place the battery under the burning sun.

Gimbal Maintenance

The gimbal of the FIMI X8 Tele is an integrated unit and does not require disassembly. When storing the aircraft, please be careful not to scratch or collide with the camera, and pay attention to keeping the camera clean.

Drone Self-check

The drone enters the self-check when the drone is powered on. If the self-check failed, App will pop up corresponding hints.

Firmware Upgrade

- Please regularly check the firmware version number, as new firmware updates will be pushed through Fimi Navi 3.0, prompting you to update.
- After connecting Fimi Navi 3.0 App to the aircraft and remote controller, download the new firmware.
- Once the firmware download is complete, Fimi Navi 3.0 App will prompt you to upgrade.
- Follow the prompts to complete the upgrade.



- The entire upgrade process will take approximately 10 minutes.
- During the upgrade process, the aircraft may exhibit the following conditions: gimbal limpness, abnormal blinking of status indicator lights, or self-rebooting. These are all normal occurrences, so please be patient and wait for the firmware upgrade to complete.
- Internet connection is required during the upgrade.
- Ensure that the aircraft has at least 50% battery power and the remote controller has at least 40% battery power before starting the upgrade.
- Do not plug or unplug the USB data cable during the upgrade process.

FIMI Enhanced Video Transmission Module

Disclaimer

Thank you for purchasing our product. To protect your legal rights and interests, please carefully read the product user manual provided with this product before use. FIMI Technology Co., Ltd. (hereinafter referred to as "FIMI Technology") reserves the right to update the aforementioned documents. Before assembly, setup, and use, please visit the FIMI official website (<http://www.fimi.com>) to download the manual and read it carefully.

1. FIMI Technology shall not be liable for any consequences resulting from the purchase and maintenance of this product through unofficial channels.
2. Once you begin using this product, it is deemed that you have read, understood, acknowledged, and accepted all the terms and content of the product manual and disclaimer.
3. During the use of this product, it is imperative to strictly adhere to and execute the requirements specified in the manual. FIMI Technology is not responsible for any adverse consequences resulting from failure to carefully read the product manual or watch instructional videos.
4. Users are solely responsible for any personal injury, accidents, property damage, legal disputes arising from violations of safety instructions, or adverse events resulting from uncontrollable factors. FIMI Technology will not assume any responsibility.
5. FIMI Technology shall not be liable for any actions directly or indirectly violating applicable laws and regulations carried out by users when using this product.
6. Unauthorized modification of this product leading to property damage or personal injury will absolve FIMI Technology from any compensation and legal liability.
7. The data usage incurred by inserting a SIM card and using the 4G module is the user's own responsibility.
8. National laws and regulations impose restrictions on the flight areas of civilian drones. Users are advised to understand the local regulations before using this product for flight. Users are fully responsible for any legal liabilities arising from non-compliance with the above provisions.
9. This product should not be used in adverse weather conditions such as rain, snow, thunderstorms, strong winds, fog, or environments with strong magnetic interference. Otherwise, users will bear the losses resulting from product damage.
10. FIMI Technology does not provide free repair services for product damage caused by subjective judgment or human operational errors by users.
11. Users will bear full responsibility for fires or explosions caused by improper actions such as artificial short circuits or modifications.
12. For issues not covered in this disclaimer, please refer to relevant local laws and regulations. In case of conflict between this disclaimer and local laws and regulations, the latter shall prevail.
13. It is prohibited for individuals under the age of 16 and others who do not have full legal capacity to use this product.
14. It is prohibited to use this product in crowded places.
15. It is prohibited to use this product in areas restricted by laws or relevant regulatory authorities.
16. Please do not use this product under conditions of alcohol consumption, fatigue, influence of drugs, or other physical or mental impairments.
17. The final interpretation right of this product-related disclaimer and explanatory documents belongs to FIMI Technology.

Overview

The FIMI Enhanced Video Transmission Module can be installed as an expansion module on FIMI drones (please refer to official website information for specific supported models). In cases where the remote control signal exceeds the operating range or is obstructed, the drone can still be controlled via a 4G connection.

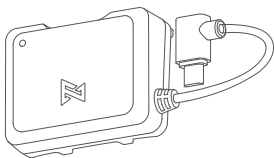

Module Installation

Install the module as shown in the diagram:

- Unfolding the flying machine arm
- Open the interface cover
- Follow the arrows to install the module and connect the micro USB.

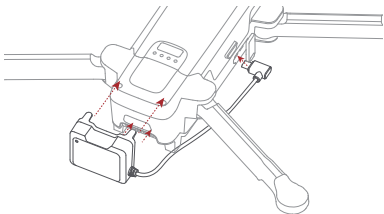

- After installation, the status should be as follows:

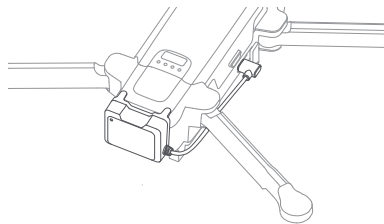

SIM Card Installation

Install the SIM card as shown in the diagram:

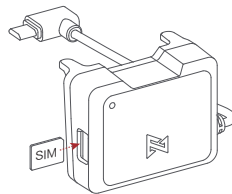

- Insert the SIM card according to the direction indicated by the red arrow.



SIM Card Usage and Selection Instructions

- The enhanced video transmission module uses a nano SIM card.
- It is recommended to choose a SIM card from the same carrier to effectively reduce latency and improve video transmission stability.

Indicator Light Definition

Indicator Light Status	Enhanced Video Transmission Module Status
	No SIM card detected or SIM card has no network
	Network is normal
	Module is not connected to the aircraft or the aircraft is not powered on

 LED is always on  LED is flashing regularly  LED is off

Enhanced Video Transmission Usage



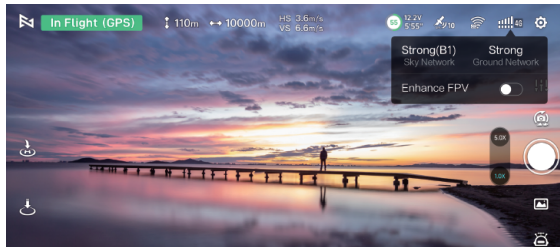

1. Power on the aircraft and remote controller, ensuring they are properly connected.
2. Enter the FIMI Navi 3.0 App video transmission interface, where the 4G signal icon will pop up in the signal display area " ".
3. Click to view the 4G network status.

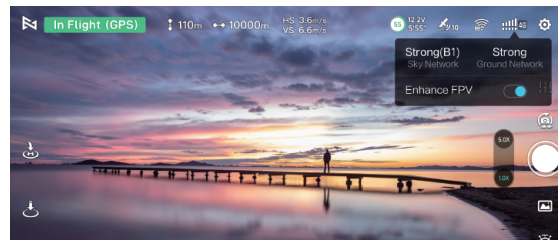

4. Click the enhanced transmission switch to start using 4G enhanced transmission.



5. Signal Status Indicators

-  4G : Network connection normal, 4G signal normal, using enhanced transmission.
-  4G : Different signal strength statuses.
-  4G : No nanoSIM card detected or nanoSIM is inactive.
-  4G : Enhanced transmission not in use.
-  4G : Click to toggle enhanced transmission on/off; default is off.



- It is recommended to use the phone's native cellular network for a better experience.
- When replacing or installing a physical nano SIM card, there is no need to remove the FIMI enhanced transmission module from the drone. After replacing the nano SIM card, you need to unplug and reinsert the micro USB connection.
- After turning on enhanced transmission, be sure to monitor the transmission signal strength and ensure flight safety. Click the 4G signal icon to check signal strength.

- Enhanced transmission uses the phone's 4G network for data transfer. During use, it is advisable to turn off the phone's Wi-Fi to reduce interference and avoid affecting transmission delay and stability.
- Due to limitations of Android/iOS systems, phone calls may restrict background operations and prevent the use of the 4G network, potentially making enhanced transmission unavailable and causing the aircraft to lose connection and return.
- In urban environments with tall buildings, ensure that you set an appropriate return-to-home altitude (above buildings).
- Avoid flying beyond visual line of sight, especially at night.
- When the app indicates weak 4G transmission signal, exercise caution during flight.

Precautions

- The enhanced video transmission module relies on a 4G connection for video transmission, and the stability of video transmission depends entirely on the signal quality and network congestion in the current operating environment. Before flight, ensure that both the ground end (usually a smartphone) and the aircraft end (enhanced video transmission module) have full signal strength. Due to the inherent latency in 4G signal transmission, please observe the flying environment carefully during flight to avoid collisions with obstacles. If the aircraft is flying in an area with no 4G signal, it will initiate a return-to-home operation. Before flight, pay attention to the settings of the return-to-home point and altitude.
- When flying at altitudes higher than 100 meters, the quality of the 4G signal will rapidly decrease, and connection stability will be reduced. Pay attention to the flying altitude during flight.
- During normal operation, the enhanced video transmission module consumes approximately 1GB of data every 30 minutes. Please monitor data usage carefully during actual operation.
- For working frequency bands in other regions, please pay attention to the official website product instruction manual for updates.

Specifications

Technical standard	TDD-LTE/FDD-LTE/WCDMA
Working frequency	TDD-LTE: Band 38/39/40/41 FDD-LTE: Band 1/3/5/8 WCDMA: Band 1/8
Interface	MicroUSB interface nano-SIM card interface Onboard ipex first generation antenna interface
Antenna	Built-in FPC dual antenna, supports external antenna
Dimensions	49x38x26mm (Does not include wire length)
Product Weight	19g
Input	5V  1.5A
Operating temperature	Normal operating temperature: -10°C ~ +60°C Storage temperature: -20°C ~ +80°C

Basic Specification

Drone

Dimensions: Folded (without propellers): 204×106×72.6mm

Unfolded (without propellers): 242×334×72.6mm

Takeoff weight: Approx. 780 g

Diagonal size: 372mm

Max ascending speed: 5m/s

Max descending speed: 4m/s

Max flight speed: 18m/s *in a windless environment at sea level

Maximum takeoff altitude: ≤5000 meters

Maximum hover time: 29 minutes *Under windless conditions, with the aircraft's

vision system disabled, camera parameters set to 720p/30fps, and recording mode turned off, hovering at sea level until the remaining 0% battery is depleted provides a reference point only. Please pay attention to the app prompts during actual flight.

Maximum flight time: 38/47 minutes *Under windless conditions, with the aircraft's vision system disabled, camera parameters set to 720p/30fps, and recording mode turned off, flying forward at a speed of 25.2 kilometers per hour at sea level until the remaining 0% battery is depleted provides a reference point only. Please pay attention to the app prompts during actual flight.

Maximum tilt angle: 35°

Maximum wind speed resistance: 12m/s

Operating temperature range: 0°C ~ 40°C

Satellite navigation systems: GPS/Galileo/GLONASS

Hovering accuracy: Vertical: ±0.1 meters (Visual positioning is working normally)

±0.5 meters (Positioning system is working normally)

Horizontal: ±0.3 meters (Visual positioning is working normally)

±0.5 meters (Positioning system is working normally)

Expansion port: 12-PIN data interface(female)

Remote controller

Product weight: Approx. 373g

Dimensions: 204x91x47mm

Operating frequency: 2.400-2.4835GHz

5.725-5.850 GHz

Max battery life: Without charging mobile devices: 8 hours

Charging mobile devices: 4 hours *Tested with mobile device battery level

above 95%. Results may vary with different mobile devices and their battery levels at the time of testing. Actual usage may vary.

Type: Li-ion

Capacity: 3900mAh

Nominal voltage: 3.7V

Input: 5 V ~ 2A

Operating temperature: 0 ~ 40°C

Charging temperature: 5~40°C

Max signal effective range

(without interference, without obstruction) FCC: Approx. 10 km *The above data is measured in an open

outdoor environment without interference, and represents the maximum communication distance in a single direction flight under each standard. Please pay attention to the return prompts in the app during actual flight.

Minimum latency: Approx. 120 milliseconds

Supported mobile device interface types: Lightning, USB-C, Micro-USB

Gimbal

Three-axis mechanical gimbal (Pitch, Roll, Yaw)

Structural design range: Pitch: -115° to 40°

Roll: -40° to 40°

Yaw: -40° to 40°

Controllable rotation range: 10° to -90° (pitch)

Angular vibration range: ±0.005°

Perception System

Front vision: Accurate distance measurement range: 0.5 - 20 meters

Effective obstacle avoidance speed: flight speed less than 8m/s

Back vision: Accurate distance measurement range: 0.5 - 16 meters

Effective obstacle avoidance speed: flight speed less than 6m/s

Downward vision positioning: Monocular optical flow, TOF ranging

Accurate distance measurement range: 0.3 - 6 meters

Downward auxiliary light: Dual LED

Effective usage environment: Surface with diffuse reflection material, rich surface texture, reflectivity greater than 20% (e.g., concrete surface), adequate lighting conditions (greater than 15 lux, typical indoor daylight illumination).

Camera

Wide-angle camera

Image sensor: 1/2-inch CMOS

Lens: FOV 79°

Aperture: F/1.6

Format length: 4.71mm

Format equivalent: 24 mm

Focus range: 1m to ∞

Effective pixels: 48 million

ISO range: Video manual 100-6400

Video automatic 100-25600

Photo 100-6400

Shutter speed: 1/8000s - 2s

Maximum photo size: 8064 × 6048

Maximum video resolution:

3840 × 2160 @ 60/30/25/24fps

Maximum video bitrate: 100 Mbps

Video format: MP4

Photo formats: JPEG/DNG

File systems: FAT32/exFAT

Digital zoom: 1-5x

Telephoto camera

Image sensor: 1/2.5-inch CMOS

Lens: FOV 21.5°

Aperture: F/3.0

Format length: 14.46mm

Format equivalent: 120mm

Focus range: 10m to ∞

Effective pixels: 13 million

ISO range: Video 100-6400

Photo 100-6400

Shutter speed: 1/8000s - 2s

Maximum photo size: 4000 × 3000

Maximum video resolution:

3840 × 2160 @ 30/25/24fps

Maximum video bitrate: 100 Mbps

Video format: MP4

Image formats: JPEG/DNG

File systems: FAT32/exFAT

Digital zoom: 5-30x

Intelligent Flight Battery

Capacity: 4650mAh

Weight: Approx. 260g

Nominal Voltage: 11.55V

Charging Limit voltage: 13.2V

Energy: 53.7Wh

Battery type: Li-Po 3S

Charging time: Approx.110 minutes

Intelligent Flight Battery Plus

Capacity: 5000mAh

Weight: Approx. 330g

Nominal Voltage: 14.4V

Charging Limit voltage: 16.8V

Energy: 72Wh

Battery type: Li-ion 4S

Charging time: Approx.110 minutes

Charger

Input: 100 - 240V (AC), 50 - 60 Hz, 1.5 A

Output: USB-C 5V ≡ 3A 9V ≡ 3A 12V ≡ 3A 15V ≡ 3A 20V ≡ 2.25A

Rated power: 45W

Smart charging Case

Input: USB-C 5 - 20V

Output (Charging) Battery interface: 13.05- 17.6V

Fast Charging Protocol: Support PD, QC3.0

Operating Temperature: 5°C-40°C

Bluetooth

Protocol: 5.1

Operating frequency: 2.400 GHz - 2.4835 GHz

Recommended SD Card List:

SanDisk Extreme PRO 32GB V30 U3 A1 microSDHC

SanDisk Extreme PRO 64GB V30 U3 A1 microSDHC

SanDisk Extreme PRO 128GB V30 U3 A1 microSDHC

SanDisk Extreme PRO 256GB V30 U3 A1 microSDHC

Lexar 1066x 64GB V30 U3 A2 microSDXC

Lexar 1066x 128GB V30 U3 A2 microSDXC

Lexar 1066x 256GB V30 U3 A2 microSDXC

Lexar 1066x 512GB V30 U3 A2 microSDXC

Kingston Canvas GO! Plus 64GB V30 U3 A2 microSDXC

Kingston Canvas GO! Plus 128GB V30 U3 A2 microSDXC

Kingston Canvas React Plus 64GB V90 U3 A1 microSDXC

Kingston Canvas React Plus 128GB V90 U3 A1 microSDXC

Kingston Canvas React Plus 256GB V90 U3 A1 microSDXC

Samsung EVO Plus 512GB V30 U3 A2 microSDXC

App

FIMI Navi 3.0 Mobile Device System Requirements

iOS 12.0 or later, Android 9.0 or later



This manual may be updated without further notice. Please visit the Fimi official website for the latest version: <https://www.fimi.com>

This manual introduces the high-performance version of the battery and charging kit. Please refer to the actual purchase for specific specifications.

This device complies with Part 15 of the FCC Rules. Operation is subject to the following two conditions:

- (1) this device may not cause harmful interference, and
- (2) this device must accept any interference received, including interference that may cause undesired operation.

FCC warning:

Any Changes or modifications not expressly approved by the party responsible for compliance could void the user's authority to operate the equipment.

Note: This equipment has been tested and found to comply with the limits for a Class B digital device, pursuant to part 15 of the FCC Rules. These limits are designed to provide reasonable protection against harmful interference in a residential installation. This equipment generates uses and can radiate radio frequency energy and, if not installed and used in accordance with the instructions, may cause harmful interference to radio communications. However, there is no guarantee that interference will not occur in a particular installation. If this equipment does cause harmful interference to radio or television reception, which can be determined by turning the equipment off and on, the user is encouraged to try to correct the interference by one or more of the following measures:

- Reorient or relocate the receiving antenna.
- Increase the separation between the equipment and receiver.
- Connect the equipment into an outlet on a circuit different from that to which the receiver is connected.
- Consult the dealer or an experienced radio/TV technician for help.

The device has been evaluated